

Art. 40813

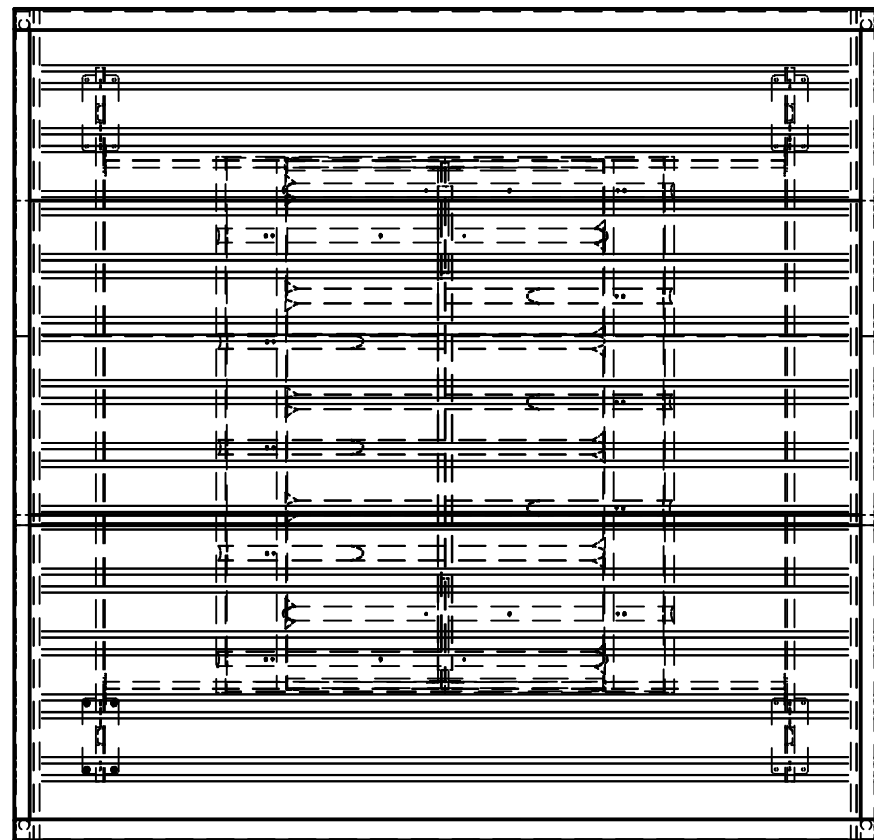

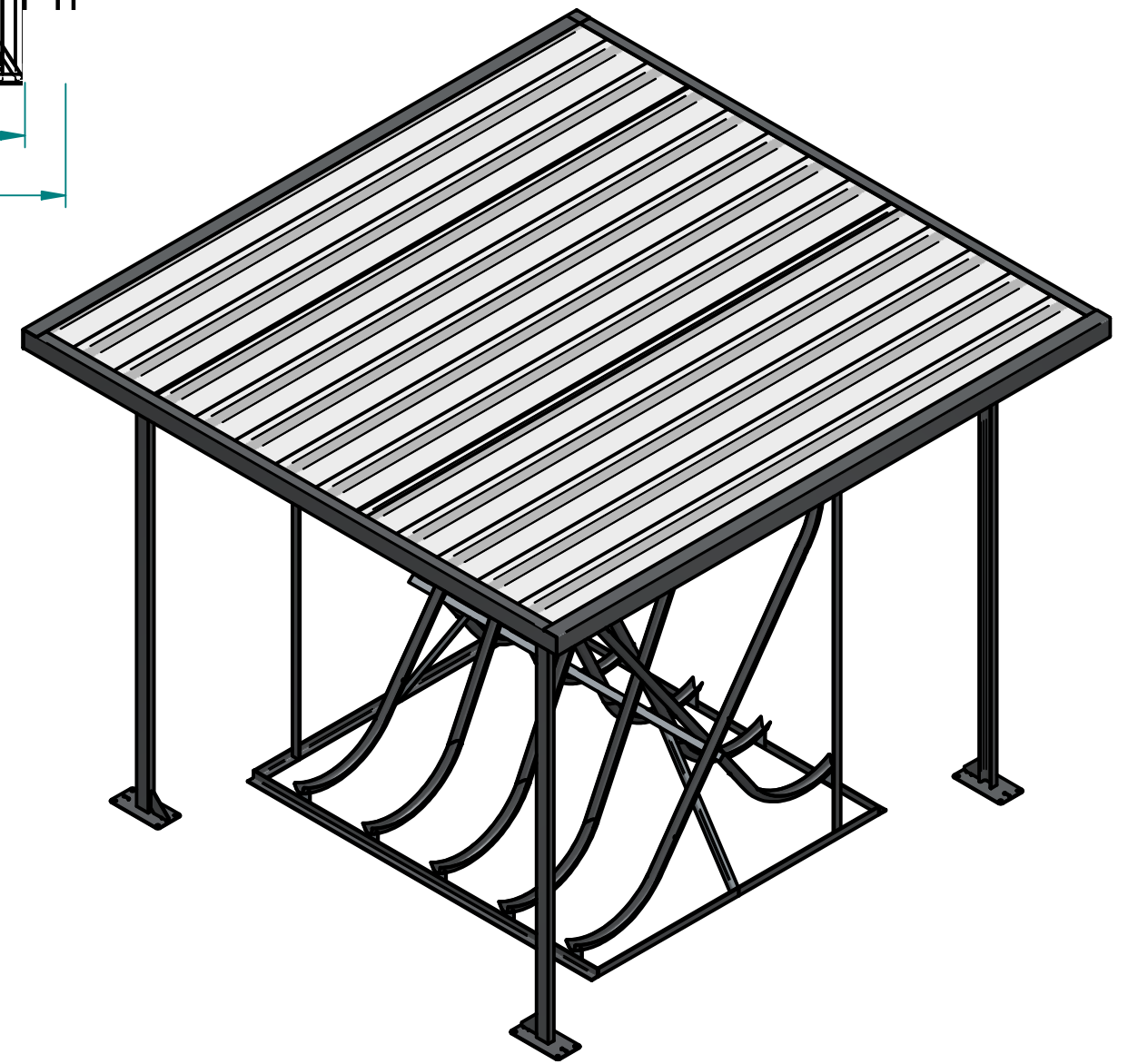

Art. 40814

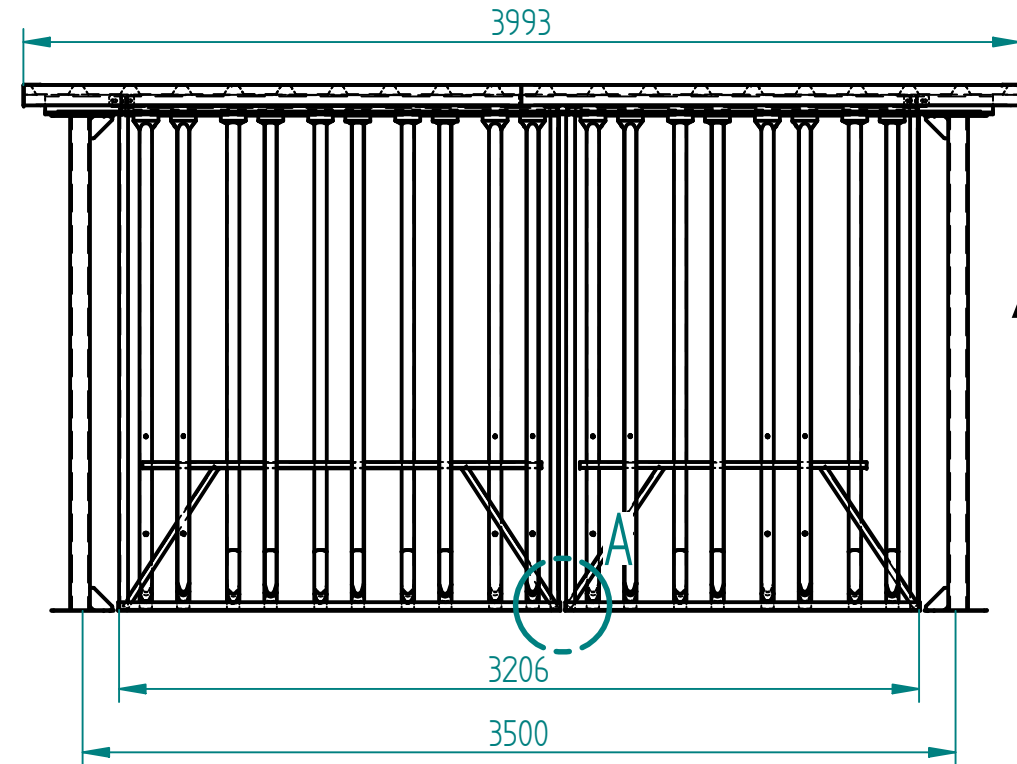
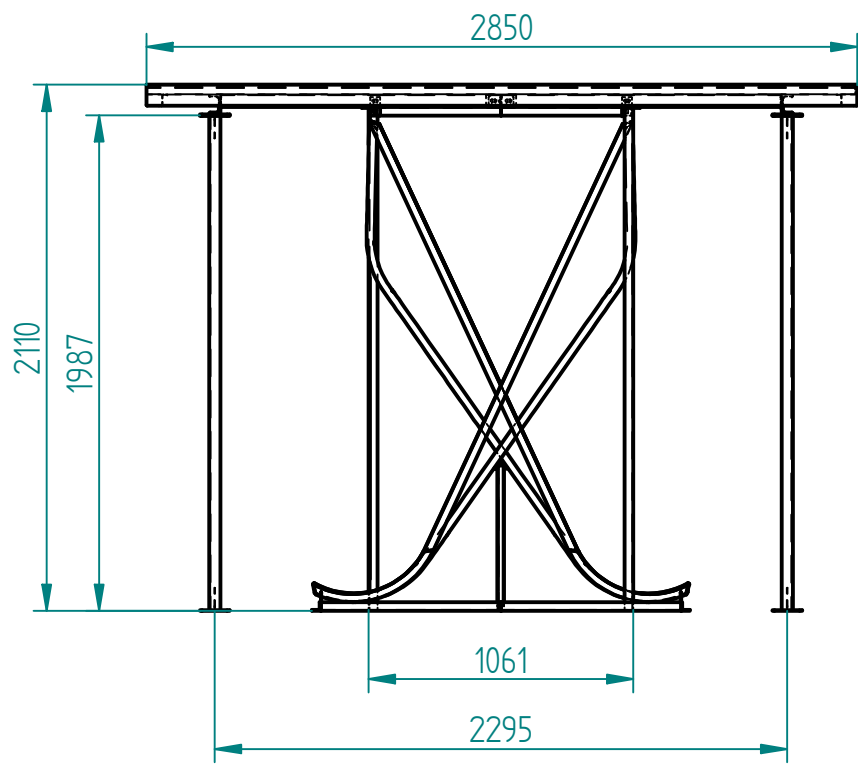
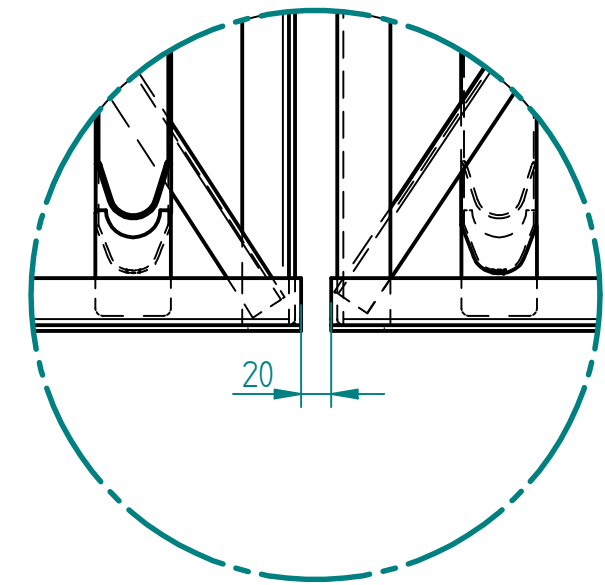
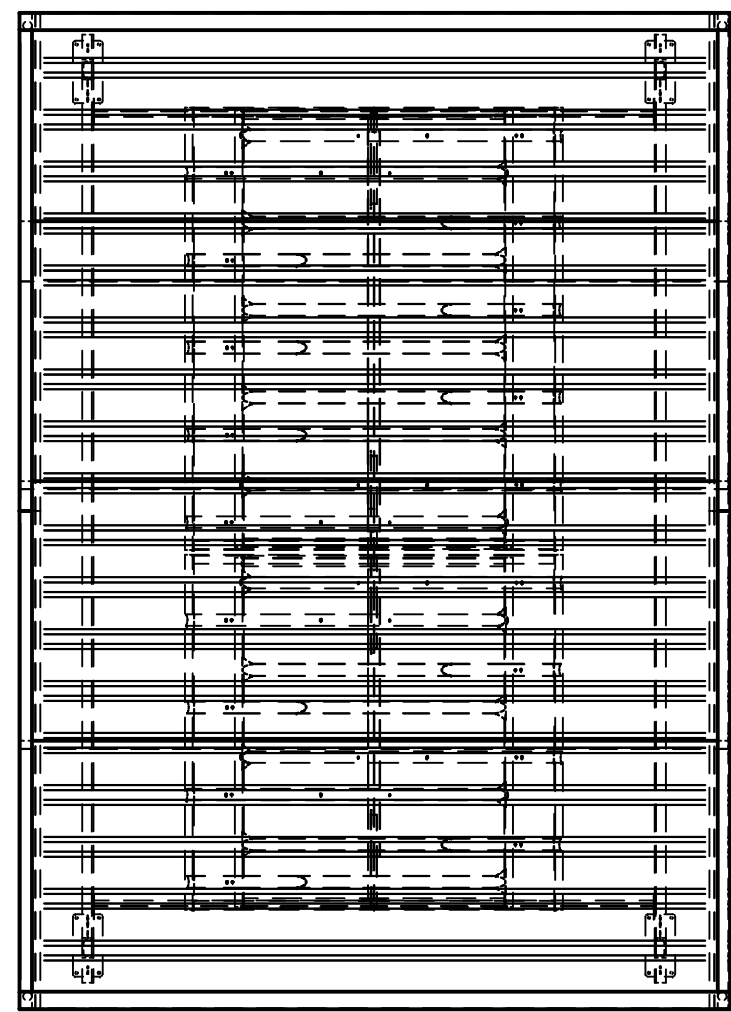

EINZELHEIT A

